



# SPACERS

**SAFEGUARD YOUR PRODUCTS**

Designers and consumers today are looking to utilize all the space available in their cabinets and are demanding more options like Roll-Out Trays for Pantries and Base Cabinets. Adding these options has created a larger demand for customized spacers.

Tenn-Tex Plastics supplies a variety of spacers for Hinges, Side Mount and Undermount Drawer Slides. We offer you The Simple Solution for your Spacer Applications.

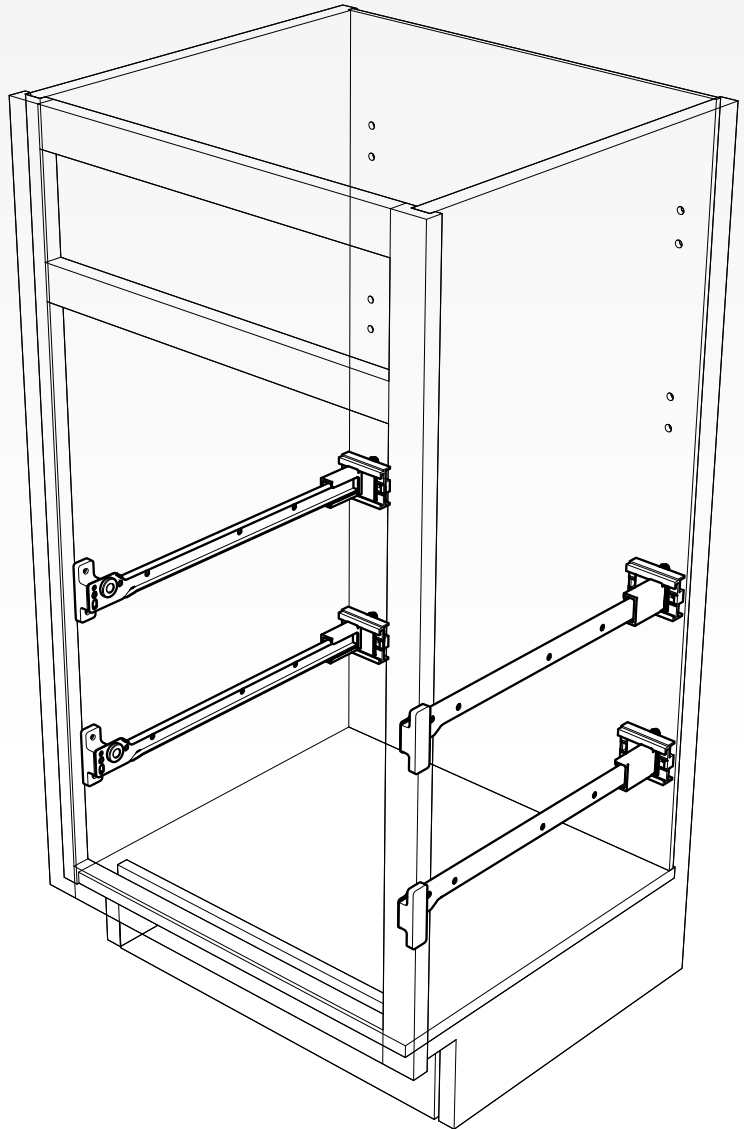
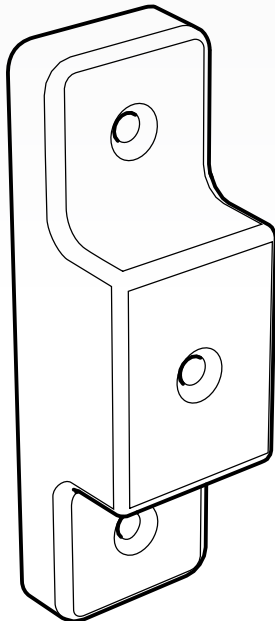

All materials ©2024 TennTex Plastics • We recommend test fitting to ensure proper function • Products in this brochure are Patented or Patent Pending.

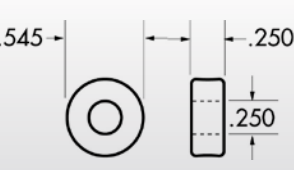
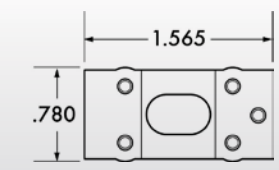
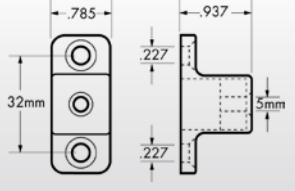
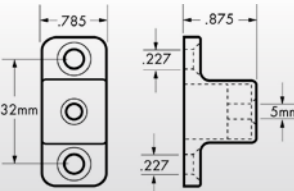
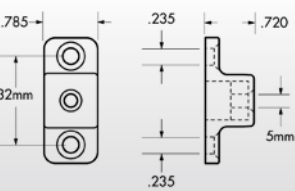
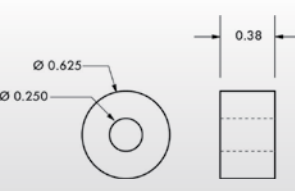
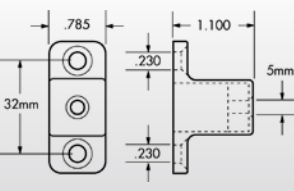
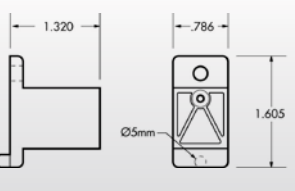
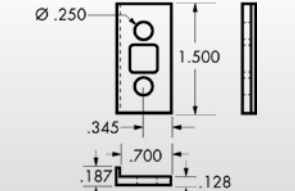
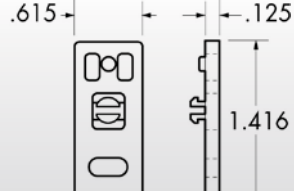
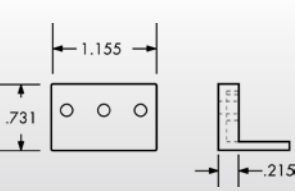
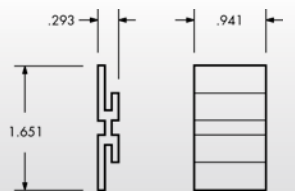
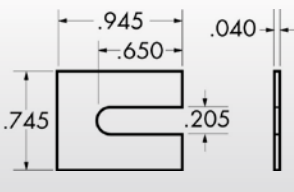
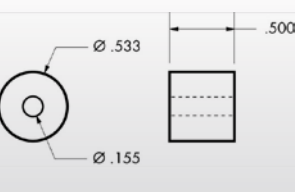

**SPACERS**

<p><b>C-068</b> Spacer .125"</p>  <p>Box wt 4 lbs Box qty 1,000 Pallet 48,000</p> <p>Colors: Natural C-068</p>	<p><b>C-073</b> Hinge Spacer .125"</p>  <p>Box wt 13 lbs Box qty 3,000 Pallet 96,000</p> <p>Colors: Natural C-073</p>	<p><b>C-080</b> Tray Spacer .937"</p>  <p>Box wt 23 lbs Box qty 1,500 Pallet 48,000</p> <p>Colors: Vanilla C-080 Natural C-080-01</p> <p>Also Available in B-109 (4 per bag with 12 euro screws)</p>
<p><b>C-095</b> Tray Spacer .875"</p>  <p>Box wt 21 lbs Box qty 1,500 Pallet 48,000</p> <p>Colors: Beige C-095</p> <p>Also Available in B-108 (4 per bag with 12 euro screws)</p>	<p><b>C-123</b> Tray Spacer .720"</p>  <p>Box wt 21 lbs Box qty 1,500 Pallet 48,000</p> <p>Colors: Natural C-123</p> <p>Also Available in B-110 (4 per bag with 12 euro screws)</p>	<p><b>C-139</b> Spacer .375"</p>  <p>Box wt 6 lbs Box qty 1,000</p> <p>Colors: Natural C-139</p>
<p><b>C-147</b> Tray Spacer 1.1"</p>  <p>Box wt 22 lbs Box qty 1,500 Pallet 48,000</p> <p>Colors: Beige C-147</p>	<p><b>C-217</b> Tray Spacer .720"</p>  <p>Box wt 27 lbs Box qty 1,000 Pallet 32,000</p> <p>Colors: Natural C-217 White C-217-01</p>	<p><b>C-218-01</b> Drawer Slide Spacer .125" Thickness</p>  <p>Box wt 35 lbs Box qty 7,000 Pallet 224,000</p> <p>Colors: White C-218-01</p>
<p><b>C-223-01</b> Drawer Slide Spacer .125" Thickness</p>  <p>Box wt 22 lbs Box qty 6,000 Pallet 192,000</p> <p>Colors: White C-223-01</p>	<p><b>C-244</b> Rollout Tray Spacer Center Stile</p>  <p>Box wt 24 lbs Box qty 2,000 Pallet 42,000</p> <p>Colors: White C-244</p>	<p><b>C-255</b> Undermount Slide Spacer</p>  <p>Box wt 19 lbs Box qty 1,800 Pallet 135,000</p> <p>Colors: Natural C-255</p>
<p><b>T-110-00</b> Hinge Spacer 1mm</p>  <p>Box wt 7 lbs Box qty 5,000 Pallet 375,000</p> <p>Colors: Natural T-110-01</p> <p>Also Available in B-415 (4 per bag) B-480 (10 per bag)</p>	<p><b>T-193</b> Spacer 1/2"</p>  <p>Box wt 19 lbs Box qty 5,000 Pallet 150,000</p> <p>Colors: Natural T-193</p>	

Trial applications are highly recommended. Some part numbers may have quantity restrictions or additional packaging options. Consult our website for dimensional drawings of parts. If you have questions on parts or availability, please contact Tenn-Tex Plastics before ordering.