



UNDERMOUNT BRACKETS

SIMPLIFYING INSTALLATION FOR UNDERMOUNT SLIDES

Drawer Slide Manufacturers have met the higher expectations from their customers with Concealed or Undermount Drawer Slides. Tenn-Tex Plastics has developed screw-on or plug-in rear brackets that use the same back drilling patterns as V-Notch Side Mount Slides, ensuring an easy transition from one slide system to the next.

Take advantage of a quick and easy installation for the slide of your choice. Tenn-Tex Plastics offers you The Simple Solutions for your Undermount Bracket Applications.

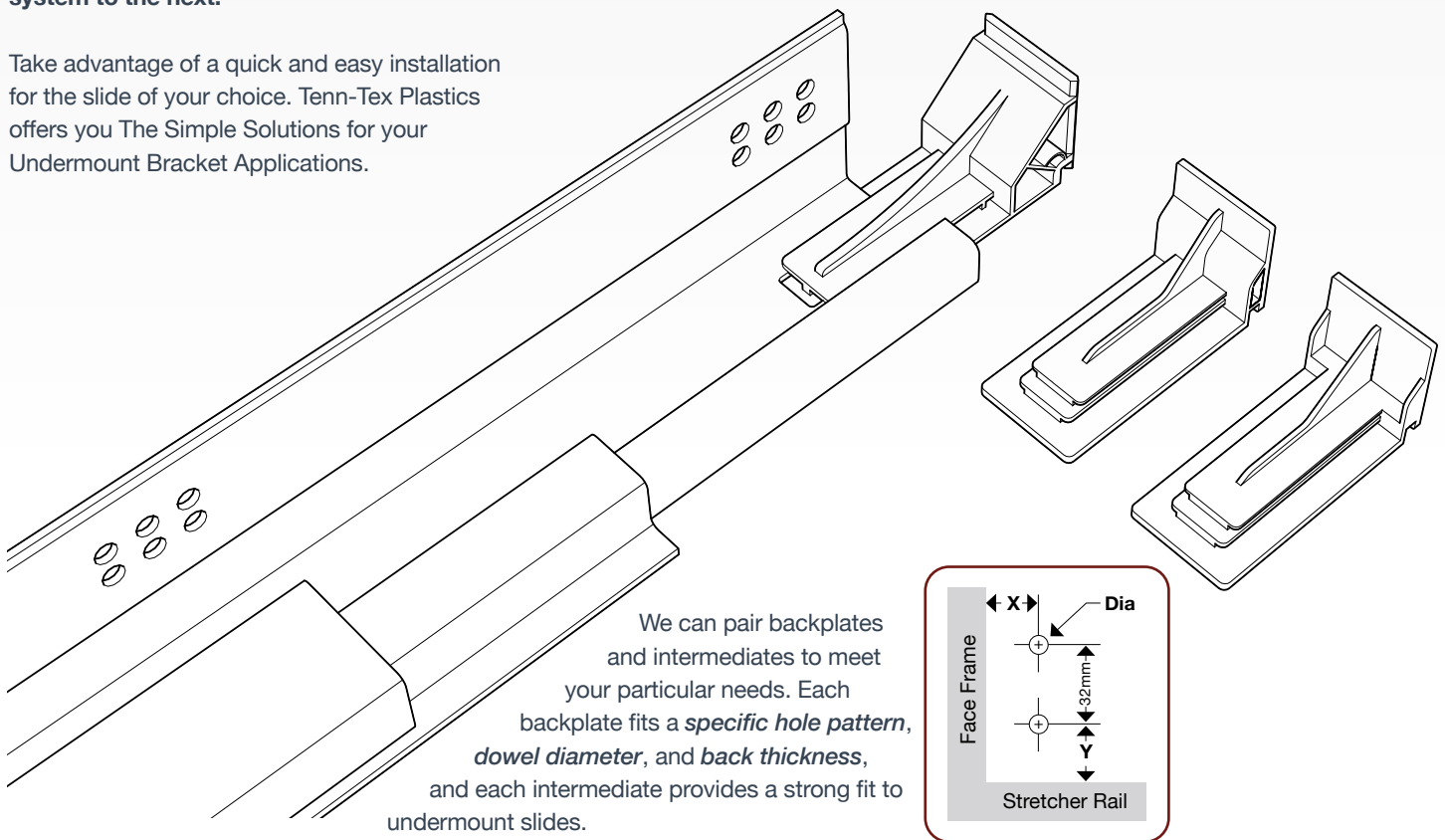

All materials ©2024 TennTex Plastics • We recommend test fitting to ensure proper function • Products in this brochure are Patented or Patent Pending. The listed slides are trademarked by their manufacturers



Scan here for more product information.

INTERMEDIATES

This is only a small sample of the Intermediates and Backplates available. If you don't see what you need here, give us a call and we will work with you to determine your best solution.

BACKPLATES

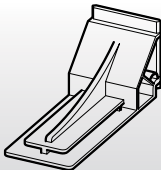
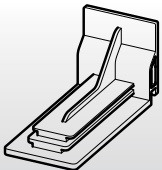
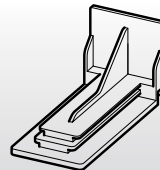
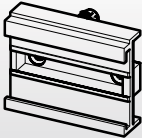
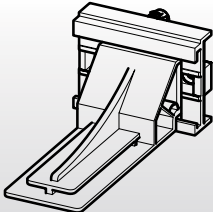
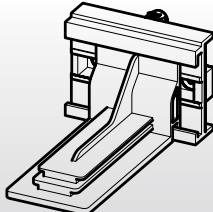
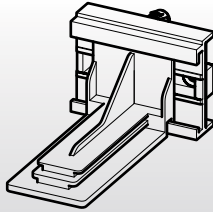
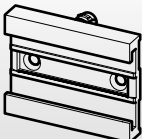
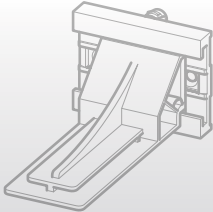
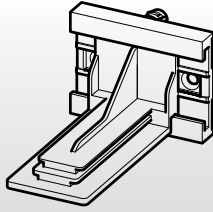
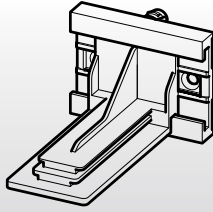
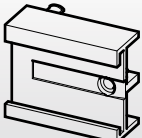
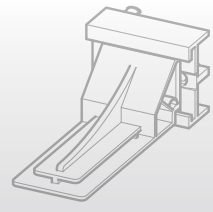
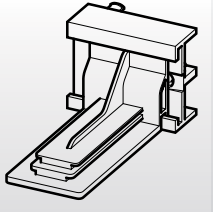
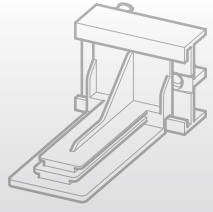
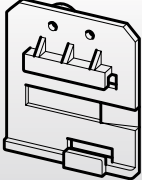
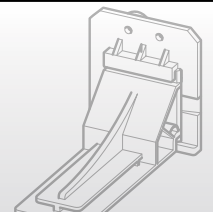
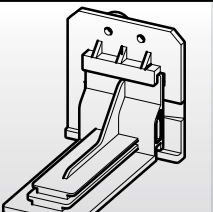
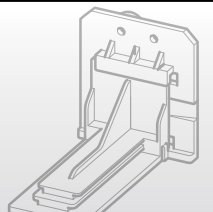
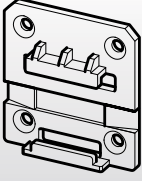
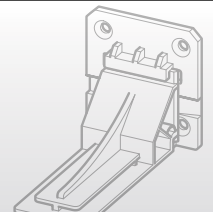
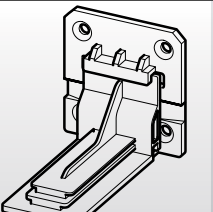
		C-575 Undermount intermediate 32mm stop		C-279 Inset Undermount intermediate 8mm stop		C-799 Undermount intermediate 8mm stop	
							
C-578 Back Bracket Universal		C-595 Undermount Bracket		C-586 Undermount Bracket		C-702 Undermount Bracket	
	Back Thickness 1/8" or more Dowel Diameter 8mm X 16mm Y 3.5mm Stop add 13mm		Box wt 28 lbs Box qty 300 Pallet 4,800		Box wt 26 lbs Box qty 300 Pallet 4,800		Box wt 34 lbs Box qty 400 Pallet 6,400
C-307 Back Bracket Universal		C-308 Undermount Bracket		C-705 Undermount Bracket			
	Back Thickness 1/8" or more Dowel Diameter 8mm Dowel Length 8.63mm X 16mm Y 3.5mm Stop add 5mm				Box wt 28 lbs Box qty 400 Pallet 6,400		Box wt 28 lbs Box qty 400 Pallet 6,400
C-293 Back Bracket Handed		C-297 Undermount Bracket		C-297 Undermount Bracket		C-297 Undermount Bracket	
	Back Thickness 1/8" Dowel Diameter 8mm Dowel Length 6.5mm X 0mm Y 3mm Stop add 13mm				Box wt 32 lbs Box qty 400 Pallet 4,800		
C-291 Back Bracket Handed		C-283 Undermount Bracket		C-283 Undermount Bracket		C-283 Undermount Bracket	
	Back Thickness 1/4" Dowel Diameter 10mm Dowel Length 14mm X 3.5(28) mm Y 8mm Stop add 3mm				Box wt 29 lbs Box qty 400 Pallet 6,400		
C-274 Back Bracket Handed, Screw On		C-280 Undermount Bracket		C-280 Undermount Bracket		C-816 Undermount Bracket	
	Back Thickness any Dowel Diameter N/A Dowel Length N/A X 1.5mm Y 6.5mm Stop add 3mm				Box wt 26 lbs Box qty 400 Pallet 4,800		Box wt 26 lbs Box qty 400 Pallet 4,800

Trial applications are highly recommended. Some part numbers may have quantity restrictions or additional packaging options. Consult our website for dimensional drawings of parts. If you have questions on parts or availability, please contact Tenn-Tex Plastics before ordering.